

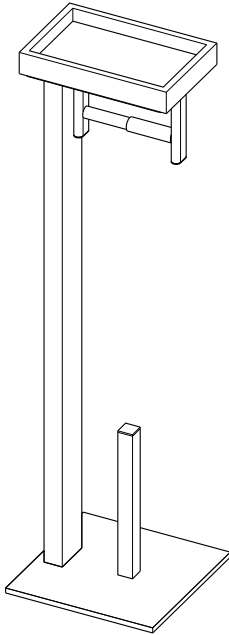









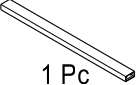

KINGSTON BRASS

THE TRADITION OF FINE BRASS

Pedestal Toilet Paper Holder with Storage Shelf Installation

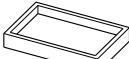

Parts:

Straight Tube(long)	Straight Tube(short)	Elliptical Tube	Washer	Bolt(long)	Bolt(short)
A  1 Pc Screw	B  1 Pc Screw	C  2 Pcs Plate	D  3 Pcs Bar	E  3 Pcs Storage Shelf	F  2 Pcs Gasket
G  4 Pcs	H  2 Pcs	I  1 Pc	J  1 Pc	K  1 Pc	L  4 Pcs

www.kingstonbrass.com

TOLL-FREE CUSTOMER SERVICE: 1-877-2-KBRASS

TECHNICAL SUPPORT E-mail: service@kingstonbrass.com

12775 Reservoir Street, Chino, CA91710

TOOLS REQUIRED

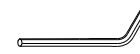

Allen Wrench



Phillips Screwdriver

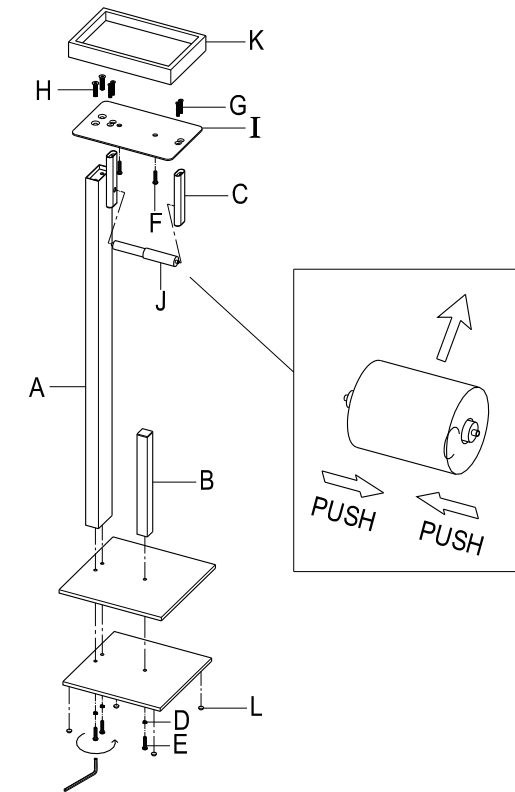

Installation Steps:

- Step 1. Place the base on a flat level surface and install straight tube (part A,B) by securing the included bolts (part E) and washers (part D) onto the bottom of the base. Tighten each bolt using an Allen wrench.
- Step 2. Install elliptical tube (part C) with hole facing inside onto the plate (part I) and secure the screws (part G) tightening with the Phillips screwdriver, then install the plate (part I) and screws (part H) into the straight tube(long) (part A) with an Allen wrench.
- Step 4. Locate the storage shelf (part K) and the bolts(short) (part F) provided, secure them into plate (part I) tightening with an Allen wrench.
- Step 5. To complete the installation, use the provided gaskets to cover the exposed corners of the bottom of the base. This helps prevent direct contact with the floorboard and extends product life.
- Step 6. Slip the toilet paper into bar (part J) and attach the bar to part C.

Cleaning

Clean with a damp cloth only.
Avoid using metal or abrasive polishes.